

Industry standard 34mm IGBT module

1200 V 100 A

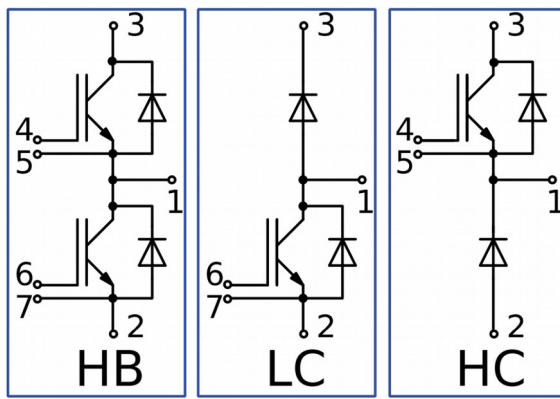
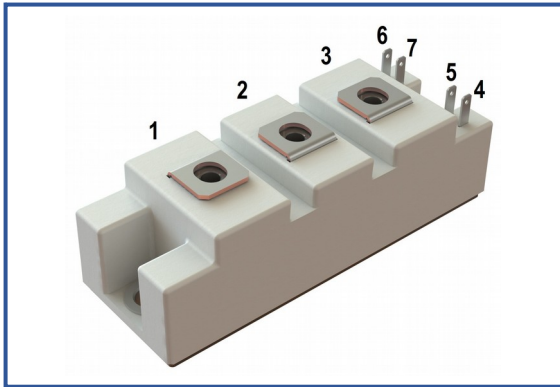

Chip features

- IGBT chip
 - Trench FS — V-Series IGBT (6th gen)
 - low $V_{CE(sat)}$ value
 - 10 μ s short circuit of 150°C
 - square RBSOA of 2xlc
 - low EMI
- FRD chip
 - fast and soft reverse recovery
 - low voltage drop

Design features

- copper baseplate
- Al_2O_3 DBC substrate
- ultrasonically welded power terminals
- Improved thermal cycling
- RoHS compliant
- UL certified file-No. E255404

Typical application

- AC motor drives
- solar inverter
- air conditioning
- high power converters and UPS

Maximum rated values

Definition	Symbol	Conditions	Value	Unit
IGBT				
Collector-Emitter voltage	V_{CES}	$V_{GE} = 0.$	1200	V
Collector current (nominal)	$I_{C\ nom}$		100	A
Collector current (maximum continuous)	$I_{C\ 25}$	$T_{vj\ (max)} = 175^{\circ}C; T_c = 25^{\circ}C.$	165	A
	$I_{C\ 80}$	$T_{vj\ (max)} = 175^{\circ}C; T_c = 80^{\circ}C.$	100	A
Repetitive peak collector current* ¹	I_{CRM}	$I_{CRM} = 3 \times I_{C\ nom}; t_p = 1\ ms.$	300	A
Short-circuit duration	t_{psc}	$T_{vj} = 25^{\circ}C; V_{GE} = \pm 15\ V; V_{CE} = 720\ V;$ $R_{G\ on} = R_{G\ off} = 1.1\ \Omega; I_{C\ max} < 750\ A.$	10	μ s
		$T_{vj} = 150^{\circ}C; V_{GE} = \pm 15\ V; V_{CE} = 720\ V;$ $R_{G\ on} = R_{G\ off} = 1.1\ \Omega; I_{C\ max} < 620\ A.$	10	
Gate-Emitter voltage	V_{GES}		± 20	V
Junction operating temperature	$T_{vj\ (op)}$		-40...+150	°C
Inverse diode \ Freewheeling diode				
Repetitive peak reverse voltage	V_{RRM}	$V_{GE} = 0\ V.$	1200	V
Forward current (nominal)	$I_{F\ nom}$		100	A
Forward current (maximum continuous)	$I_{F\ 25}$	$T_{vj\ (max)} = 175^{\circ}C; T_c = 25^{\circ}C.$	130	A
	$I_{F\ 80}$	$T_{vj\ (max)} = 175^{\circ}C; T_c = 80^{\circ}C.$	98	A
Repetitive peak forward current* ¹	I_{FRM}	$I_{FRM} = 3 \times I_{F\ nom}; t_p = 1\ ms.$	300	A
Junction operating temperature	$T_{vj\ (op)}$		-40...+150	°C
Module				
Storage temperature	T_{stg}		-55...+50	°C
Isolation voltage	V_{isol}	AC sin 50 Hz; t = 1 min.	4000	V

*¹ Pulse width and repetition rate should be such that device junction temperature does not exceed maximum T_{vj} rating

Characteristics

Definition	Symbol	Conditions	Value			Unit		
			min.	typ.	max.			
IGBT								
Collector-Emitter saturation voltage	V_{CEsat}	$V_{GE} = +15\text{ V}; I_C = 100\text{ A};$ $t_u = 1000\ \mu\text{s}.$	$T_{vj} = 25^\circ\text{C}$ $T_{vj} = 150^\circ\text{C}$	1.75 2.23	1.76 2.27	1.88 2.42	V V	
Gate-Emitter threshold voltage	$V_{GE(th)}$	$I_C = 4\text{ mA}; V_{CE} = V_{GE}; T_{vj} = 25^\circ\text{C};$ $t_u = 2\text{ ms}.$		5.70	6.08	6.45	V	
Collector-Emitter cut-off current	I_{CES}	$V_{CE} = 1200\text{ V};$ $t_u = 10\text{ ms}; V_{GE} = 0.$	$T_{vj} = 25^\circ\text{C}$ $T_{vj} = 150^\circ\text{C}$	3.81 0.61	5.08 0.70	300 2.00	μA mA	
Gate-Emitter leakage current	I_{GES}	$V_{CE} = 0; V_{GE} = \pm 20\text{ V}; T_{vj} = 25^\circ\text{C};$ $t_u = 30\text{ ms}.$		2.17	8.75	200	nA	
Input capacitance	C_{ies}	$V_{CE} = 10\text{ V}; V_{GE} = 0\text{ V};$ $f = 1\text{ MHz}; T_{vj} = 25^\circ\text{C}.$		-	9.10	-	nF	
Output capacitance	C_{oes}		-	0.70	-	nF		
Reverse transfer capacitance	C_{res}		-	0.80	-	nF		
Total gate charge	Q_G	$I_C = 100\text{ A}; V_{CE} = 600\text{ V};$ $V_{GE} = -8 \div 15\text{ V}.$		-	1040	1117	nC	
Internal gate resistance	R_{Gint}	$T_{vj} = 25^\circ\text{C}.$		-	7.50	-	Ω	
Turn-on delay time	$t_{d(on)}$	$V_{CE} = 600\text{ V};$ $V_{GE} = \pm 15\text{ V};$ $I_{Cmax} = 100\text{ A};$ $R_G = 1.1\ \Omega;$ $L = 300\ \mu\text{H}.$	$T_{vj} = 25^\circ\text{C}$ $T_{vj} = 150^\circ\text{C}$	360 437	376 448	430 500	ns	
Rise time	t_{ri}		$T_{vj} = 25^\circ\text{C}$ $T_{vj} = 150^\circ\text{C}$	50.0 57.0	53.0 59.0	65.0 70.0	ns	
Turn-on energy	E_{on}		$T_{vj} = 25^\circ\text{C}$ $T_{vj} = 150^\circ\text{C}$	4.82 9.99	6.20 10.8	9.00 14.0	mJ	
Turn-off delay time	$t_{d(off)}$		$T_{vj} = 25^\circ\text{C}$ $T_{vj} = 150^\circ\text{C}$	414 558	462 569	550 630	ns	
Fall time	t_{fi}		$T_{vj} = 25^\circ\text{C}$ $T_{vj} = 150^\circ\text{C}$	194 361	238 395	320 510	ns	
Turn-off energy	E_{off}		$T_{vj} = 25^\circ\text{C}$ $T_{vj} = 150^\circ\text{C}$	7.57 10.8	8.05 11.5	10.0 15.0	mJ	
Collector-emitter threshold voltage	V_{CE0}		$V_{GE} = +15\text{ V}; T_{vj} = 150^\circ\text{C};$		0.84	0.86	0.89	V
On-State slope resistance (IGBT)	r_{CE0}		$I_{CE1} = 25\text{ A}; I_{CE2} = 100\text{ A};$ $t_u = 1000\ \mu\text{s}.$		13.9	14.2	14.8	m Ω
Thermal resistance junction to case	$R_{th(j-c)}$		DC; $I_{CE} = 100 \pm 10\text{ A}; I_{test} = 0.5\text{ A};$ $V_{GE} = +15\text{ V}.$		-	0.197	0.270	K/W
Inverse diode \ Freewheeling diode								
Forward voltage drop	V_F	$I_F = 100\text{ A};$ $V_{GE} = 0; t_u = 1000\ \mu\text{s}.$	$T_{vj} = 25^\circ\text{C}$ $T_{vj} = 150^\circ\text{C}$	1.76 1.86	1.79 1.90	1.92 2.12	V V	
Reverse recovery time	t_{rr}	$V_{GE} = \pm 15\text{ V};$ $V_{CE} = 600\text{ V};$ $I_{Cmax} = 100\text{ A};$ $R_{Gon} = 1.1\ \Omega;$ $L = 300\ \mu\text{H}.$	$T_{vj} = 25^\circ\text{C}$ $T_{vj} = 150^\circ\text{C}$	101 157	107 161	130 180	ns ns	
Peak reverse recovery current	I_{rrM}		$T_{vj} = 25^\circ\text{C}$ $T_{vj} = 150^\circ\text{C}$	116 137	118 139	130 150	A A	
Reverse recovered charge	Q_{rr}		$T_{vj} = 25^\circ\text{C}$ $T_{vj} = 150^\circ\text{C}$	7.00 12.0	7.00 12.0	10.0 14.0	μC μC	
Reverse recovery energy	E_{rec}		$T_{vj} = 25^\circ\text{C}$ $T_{vj} = 150^\circ\text{C}$	3.00 7.00	3.00 8.00	5.00 10.0	mJ mJ	
Threshold voltage	$V_{(T0)}$		$T_{vj} = 150^\circ\text{C}; V_{GE} = 0; I_{CE1} = 25\text{ A};$		0.81	0.82	0.85	V
Forward slope resistance	r_T		$I_{CE2} = 100\text{ A}; t_u = 1000\ \mu\text{s}$		10.4	10.7	11.6	m Ω
Thermal resistance junction to case	$R_{th(jc-D)}$	DC; $I_{CE} = 80 \pm 10\text{ A}; I_{test} = 0.5\text{ A};$ $V_{GE} = +15\text{ V}.$		-	0.434	0.490	K/W	

Module							
Pin resistance	R_{Pxy}	$T_{vj} = 25^{\circ}\text{C}.$	R_{P12}	-	0.47	0.50	m Ω
			R_{P13}	-	0.66	0.66	
Parasitic inductance between terminals	L_{Pxy}	$T_{vj} = 25^{\circ}\text{C};$ $f = 1 \text{ MHz}.$	L_{P12}	-	34.5	35.0	nH
			L_{P13}	-	52.3	60.0	
Thermal resistance case to heatsink	R_{thCH}	per module		-	0.02	0.04	K/W
Mounting torque for screws to heatsink	M_s	to heatsink M6		3.00	-	5.00	N*m
Mounting torque for terminal screws	M_t	to terminals M5		1.80	2.00	2.20	N*m
Weight	W			-	150	170	g

Notes:

- Insulating material operating temperature 125°C max;
- Case temperature 125°C max;
- The recommended operating junction temperature $T_{vj\ op} = -40 \div +150^{\circ}\text{C}.$

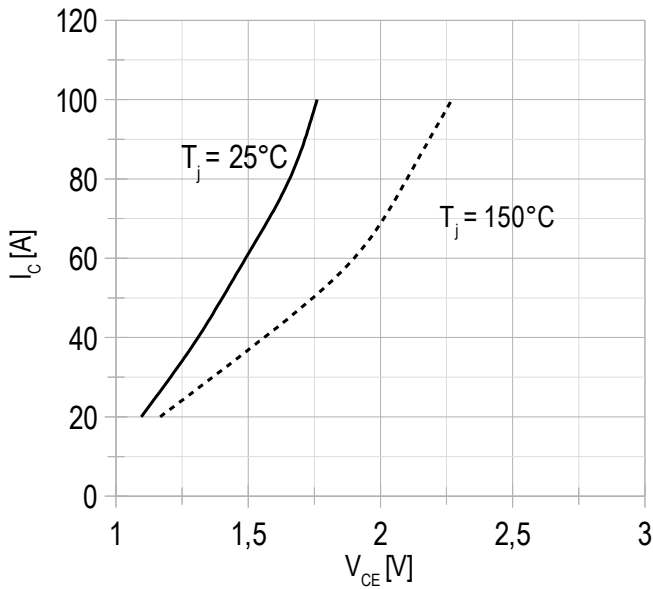
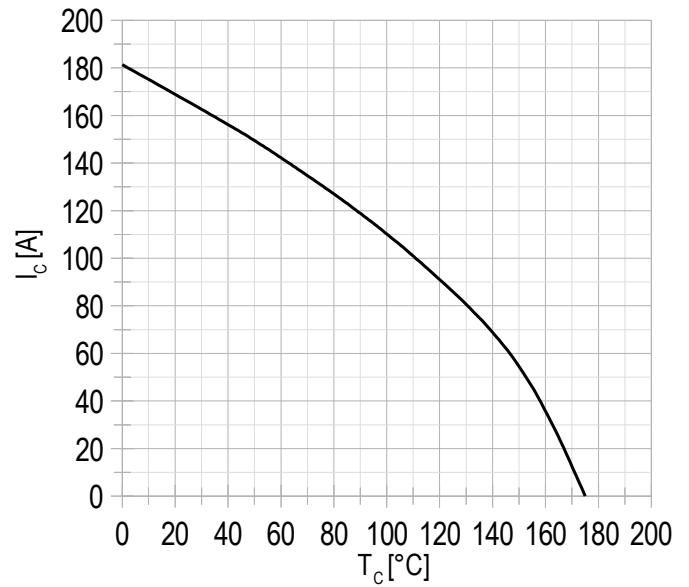
Chart 1 – typ. output characteristic, IGBT.

 $V_{GE} = +15 \text{ V.}$
Chart 2 – max. rated current vs temperature.

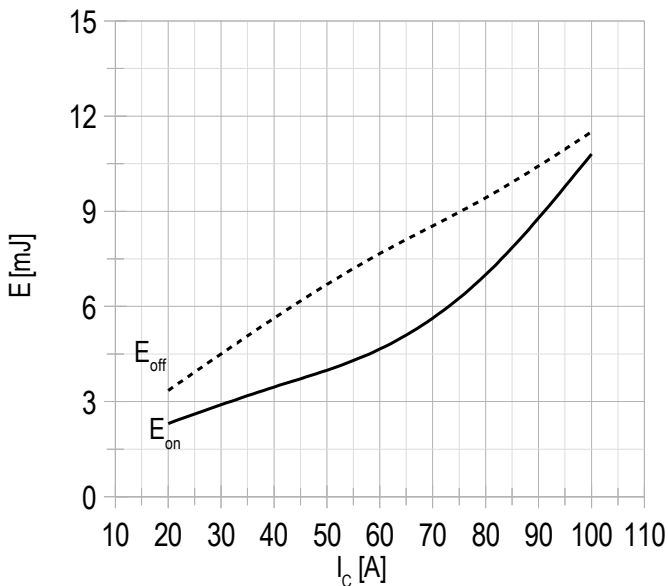
DC;
 $V_{GE} = +15 \text{ V;}$
 $T_{vj(max)} = 150^\circ\text{C.}$

Chart 3 – typ. turn-on/-off energy vs rated current, IGBT.

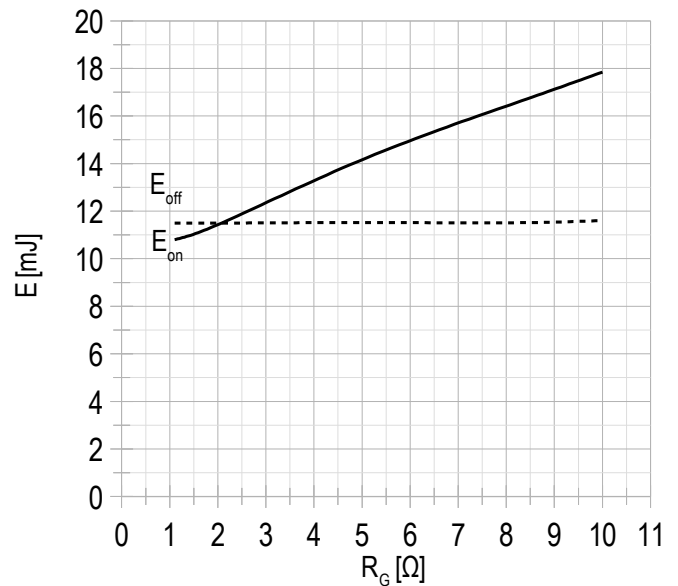
$V_{CE} = 600 \text{ V;}$
 $V_{GE} = \pm 15 \text{ V;}$
 $R_G = 1.1 \ \Omega;$
 $L = 300 \ \mu\text{H;}$
 $T_{vj(max)} = 150^\circ\text{C.}$

Chart 4 – typ. turn-on/-off energy vs gate resistance, IGBT.

$V_{CE} = 600 \text{ V;}$
 $V_{GE} = \pm 15 \text{ V;}$
 $I_{Cmax} = 100 \text{ A;}$
 $L = 300 \ \mu\text{H;}$
 $T_{vj(max)} = 150^\circ\text{C.}$

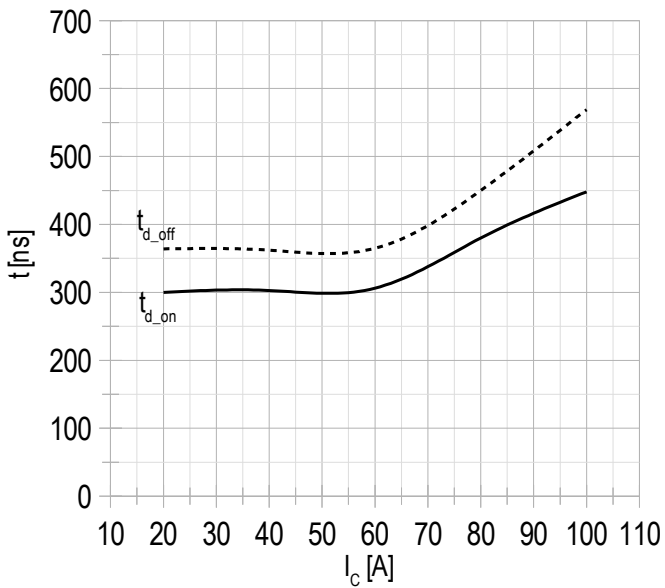
Chart 5 – typ. switching times vs rated current, IGBT.

$V_{CE} = 600\text{ V};$
 $V_{GE} = \pm 15\text{ V};$
 $R_G = 1.1\ \Omega;$
 $L = 300\ \mu\text{H};$
 $T_{vj(max)} = 150^\circ\text{C}.$

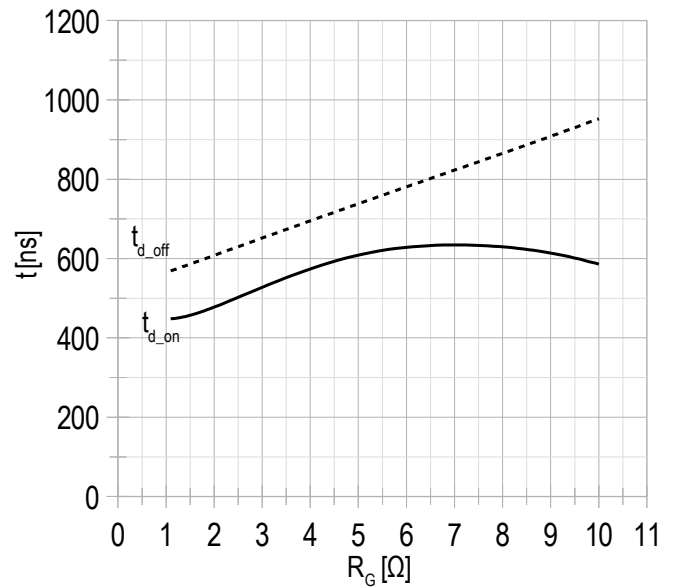
Chart 6 – typ. switching times vs gate resistance, IGBT.

$V_{CE} = 600\text{ V};$
 $V_{GE} = \pm 15\text{ V};$
 $I_{Cmax} = 100\text{ A};$
 $L = 300\ \mu\text{H};$
 $T_{vj(max)} = 150^\circ\text{C}.$

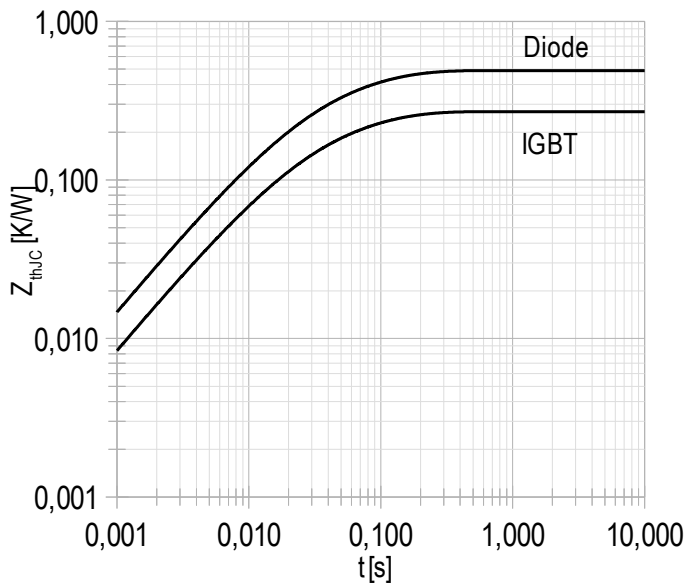
Chart 7 – max. transient thermal impedance.

Single pulse;
 $V_{GE} = +15\text{ V}.$

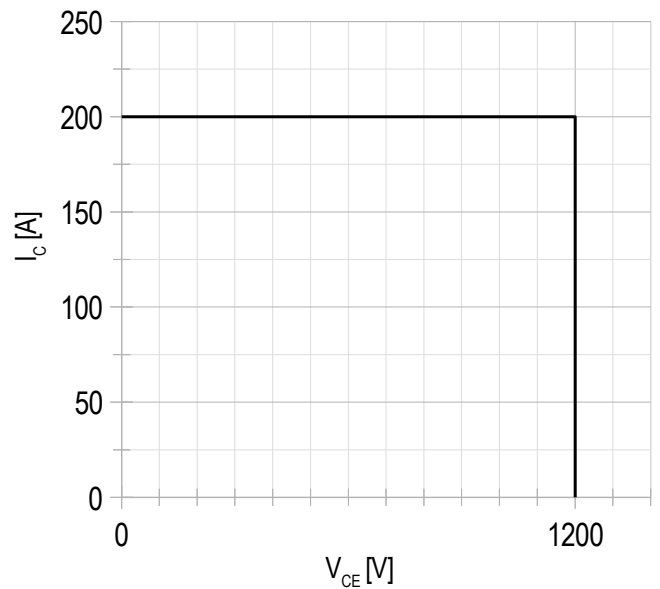
Chart 8 – RBSOA.

$V_{CEmax} = 1200\text{ V};$
 $V_{GE} = \pm 15\text{ V};$
 $I_{Cmax} = 2 * I_{Cnom};$
 $R_G = 1.1\ \Omega;$
 $L = 300\ \mu\text{H}.$

Chart 9 – typ. output characteristic, FRD.

 $V_{GE} = +15\text{ V}$.

Chart 10 – typ. switching losses vs rated current, FRD.

 $V_{GE} = \pm 15\text{ V}$;
 $V_{CE} = 600\text{ V}$;
 $L = 300\ \mu\text{H}$;
 $R_{G\ on} = 1.1\ \Omega$;
 $T_{vj\ (max)} = 150^\circ\text{C}$.

Chart 11 – typ. switching losses vs gate resistance, FRD.

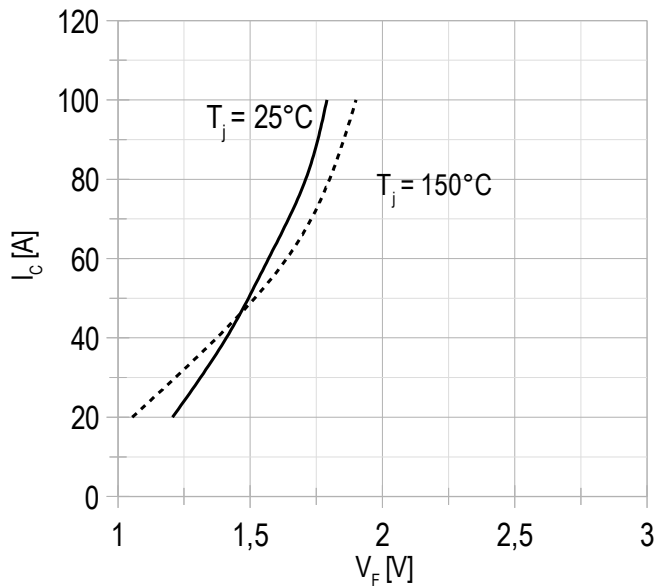
 $V_{GE} = \pm 15\text{ V}$;
 $V_{CE} = 600\text{ V}$;
 $I_{C\ max} = 100\text{ A}$;
 $L = 300\ \mu\text{H}$;
 $T_{vj\ (max)} = 150^\circ\text{C}$.

Chart 12 – typ. reverse recovered charge vs gate resistance, FRD.

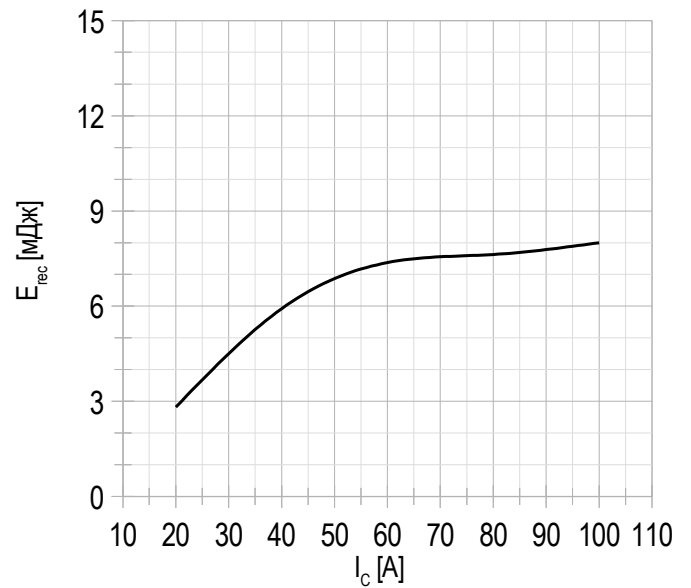
 $V_{GE} = \pm 15\text{ V}$;
 $V_{CE} = 600\text{ V}$;
 $I_{C\ max} = 100\text{ A}$;
 $L = 300\ \mu\text{H}$;
 $T_{vj\ (max)} = 150^\circ\text{C}$.

Chart 13 – typ. switching times vs rated current, FRD.

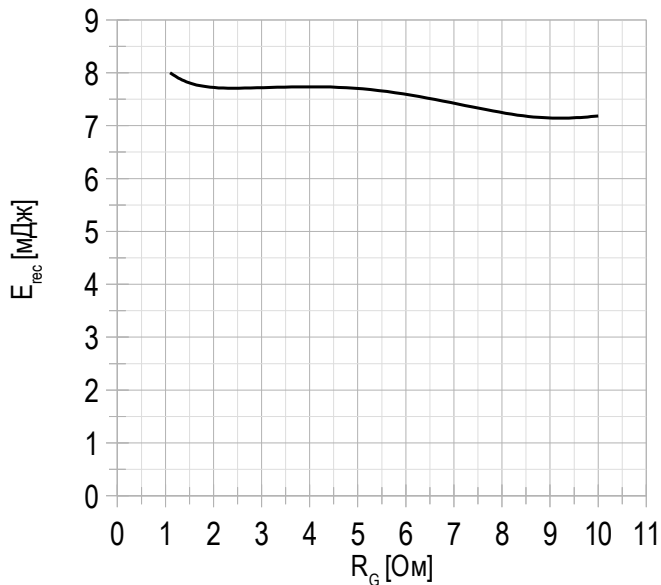
$V_{CE} = 600 \text{ V};$
 $V_{GE} = \pm 15 \text{ V};$
 $R_G = 1.1 \ \Omega;$
 $L = 300 \ \mu\text{H}.$
 $T_{vj(max)} = 150^\circ\text{C}.$

Chart 14 – typ. switching times vs gate resistance, FRD.

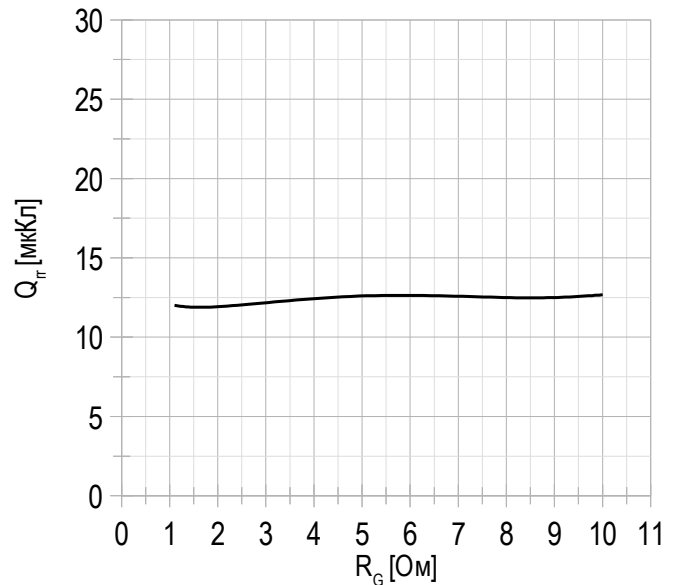
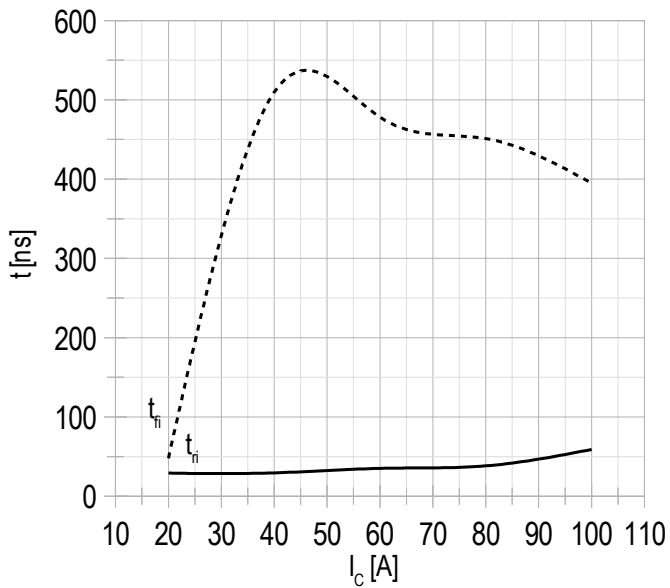
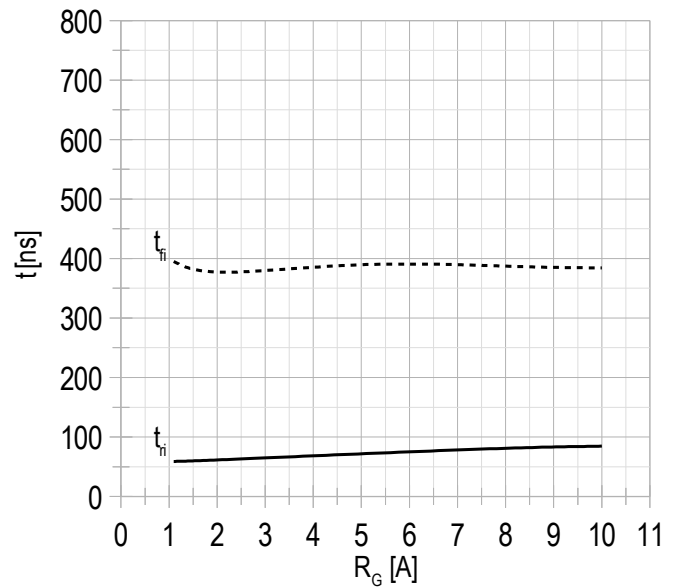
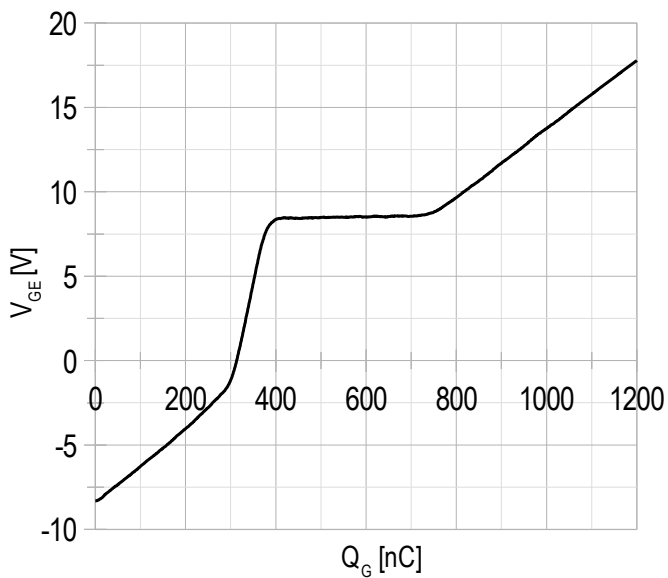
$V_{CE} = 600 \text{ V};$
 $V_{GE} = \pm 15 \text{ V};$
 $I_{Cmax} = 100 \text{ A};$
 $L = 300 \ \mu\text{H}.$
 $T_{vj(max)} = 150^\circ\text{C}.$

Chart 15 – typ. gate charge characteristic.

$I_C = 100 \text{ A};$
 $V_{CE} = 600 \text{ V};$
 $V_{GE} = -8 \div 15 \text{ V}.$

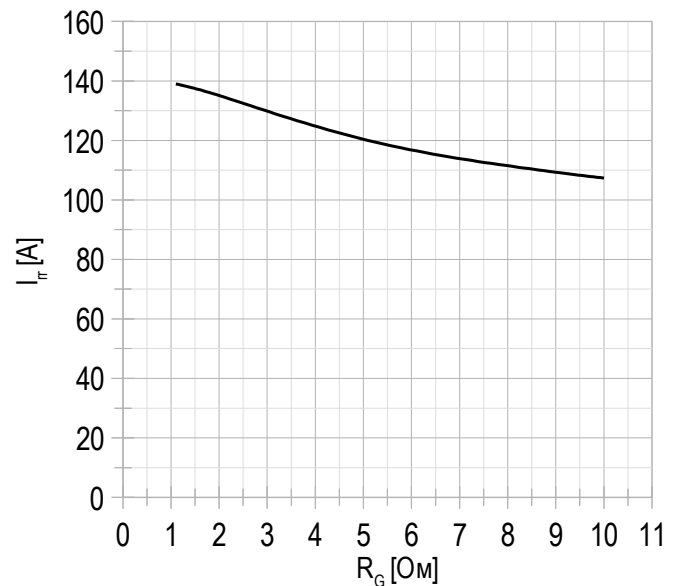
Chart 16 – typ. reverse recovery current vs gate resistance FRD.

$V_{CE} = 600 \text{ V};$
 $V_{GE} = \pm 15 \text{ V};$
 $L = 300 \ \mu\text{H}.$
 $T_{vj(max)} = 150^\circ\text{C}.$

Chart 17 – typ. rated current vs frequency.

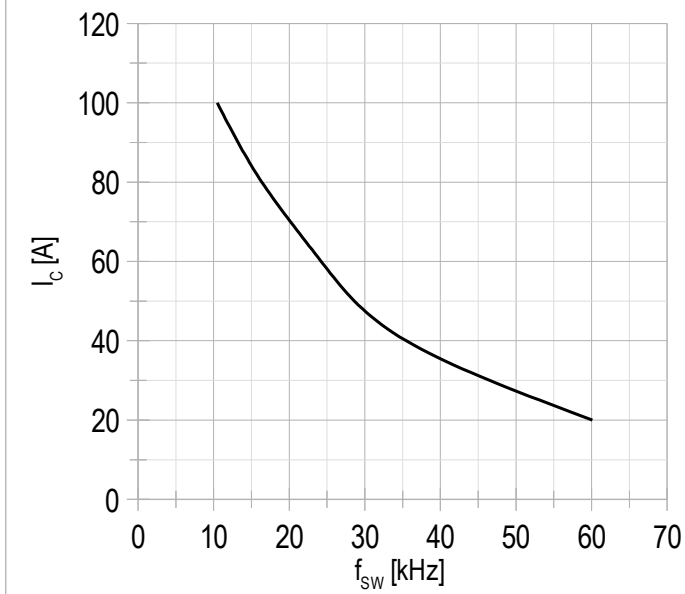

Duty cycle 50%

