

62mm Module with Ultrafast switching speed IGBT and Fast recovery diode.

#### Feature

- 150A/1200V,  $V_{CE(sat)(typ.)} = 2.9V@150A$
- Ultrafast switching speed
- Excellent short circuit ruggedness

#### Applications

- Inverter welding
- Inductive heating
- Uninterrupted Power Supply(UPS)

#### Appearance



#### Maximum Ratings of IGBT ( $T_{vj}=25^{\circ}C$ unless otherwise noted)

Items	Symbol	Conditions	Maximum Rating	Units
Collector-emitter voltage	$V_{CES}$		1200	V
Gate-emitter voltage	$V_{GES}$		$\pm 30$	V
Collector current	$I_C$	$T_{vj}=25^{\circ}C$	300	A
		$T_{vj}=100^{\circ}C$	150	A
Pulsed collector current	$I_{CM}$	$t_p=1ms$	300	A
Short circuit current	$I_{sc}$	$V_{GE} \leq 15V, V_{CC}=600V, t_p=10\mu s$ $V_{CEmax}=V_{CES}-L_s \cdot di/dt$	1040	A
Maximum power dissipation	$P_D$	$T_c=25^{\circ}C, T_{vj}=150^{\circ}C$	1250	W

#### Electrical Characteristics of IGBT ( $T_{vj}=25^{\circ}C$ unless otherwise noted)

Items	Symbol	Conditions	Min.	typ.	Max.	Units
Collector-emitter breakdown voltage	$V_{CES}$	$V_{GE}=0V, I_C=250\mu A$	1200			V
Collector -emitter leakage current	$I_{CES}$	$V_{CE}=1200V, V_{GE}=0V$			5.0	mA
Gate leakage current, forward	$I_{GES}$	$V_{GE}=20V, V_{CE}=0V$			400	nA
		$V_{GE}=-20V, V_{CE}=0V$			-400	nA
Gate threshold voltage	$V_{GE(th)}$	$V_{GE}=V_{CE}, I_C=5mA$	5.1	5.8	6.2	V
Collector-emitter saturation voltage	$V_{CE(sat)}$	$V_{GE}=15V, I_C=150A, T_{vj}=25^{\circ}C$		2.9	3.2	V
		$V_{GE}=15V, I_C=150A, T_{vj}=125^{\circ}C$		3.5	3.8	V
Integrated gate resistor	$R_{Gint}$	$f=1M; V_{pp}=1V$		2.5		$\Omega$
Input capacitance	$C_{ies}$	$V_{CE}=25V$		11		nF
Output capacitance	$C_{oes}$	$V_{GE}=0V$		1.2		nF
Reverse transfer capacitance	$C_{res}$	$f=1MHz$		0.5		nF
Total gate charge	$Q_g$	$V_{CC}=600V, V_{GE}=15V$		1.6		$\mu C$
Turn-on delay time	$t_{d(on)}$	$V_{CC}=600V$		72		ns
Rise time	$t_r$	$V_{GE}=\pm 15V$		77		ns
Turn-off delay time	$t_{d(off)}$	$I_C=150A$		428		ns
Fall time	$t_f$	$R_G=3\Omega$		146		ns
Turn-on energy loss per pulse	$E_{on}$	Inductive Load		7.0		mJ
Turn-off energy loss per pulse	$E_{off}$	$T_{vj}=125^{\circ}C$		11.9		mJ
Turn-on delay time	$t_{d(on)}$	$V_{CC}=600V$		73		ns
Rise time	$t_r$	$V_{GE}=\pm 15V$		77		ns
Turn-off delay time	$t_{d(off)}$	$I_C=150A$		435		ns
Fall time	$t_f$	$R_G=3\Omega$		156		ns
Turn-on energy loss per pulse	$E_{on}$	Inductive Load		7.8		mJ
Turn-off energy loss per pulse	$E_{off}$	$T_{vj}=150^{\circ}C$		12.3		mJ
Temperature under switching conditions	$T_{vj op}$		-55		150	$^{\circ}C$

#### Maximum Ratings of Diode

Items	Symbol	Conditions	Maximum Rating	Units
Repetitive peak reverse voltage	$V_{RRM}$	$T_{vj}=25^{\circ}\text{C}$	1200	V
Diode continuous forward current	$I_F$	$T_{vj}=25^{\circ}\text{C}$	300	A
		$T_{vj}=100^{\circ}\text{C}$	150	A
Diode maximum forward current	$I_{FM}$	$t_p=1\text{ms}, T_{vj}=25^{\circ}\text{C}$	300	A

#### Electrical Characteristics of Diode ( $T_{vj}=25^{\circ}\text{C}$ unless otherwise noted)

Items	Symbol	Conditions	Min.	typ.	Max.	Units
Diode forward voltage	$V_F$	$I_F=150\text{A}, T_{vj}=25^{\circ}\text{C}$		3.0	3.2	V
		$I_F=150\text{A}, T_{vj}=125^{\circ}\text{C}$		2.3		V
Diode reverse recovery time	$t_{rr}$	$V_{CE}=600\text{V}$		80		ns
Diode peak reverse recovery current	$I_{rr}$	$I_F=150\text{A}$		105		A
Diode reverse recovery charge	$Q_{rr}$	$dI_F/dt=2780\text{A}/\mu\text{s}$		8.7		nC
Reverse recovery energy	$E_{rec}$	$T_{vj}=125^{\circ}\text{C}$		5.0	5.2	mJ
Diode reverse recovery time	$t_{rr}$	$V_{CE}=600\text{V}$		300		ns
Diode peak reverse recovery current	$I_{rr}$	$I_F=150\text{A}$		290		A
Diode reverse recovery charge	$Q_{rr}$	$dI_F/dt=2780\text{A}/\mu\text{s}$		46.5		nC
Reverse recovery energy	$E_{rec}$	$T_{vj}=150^{\circ}\text{C}$		6.0	6.3	mJ

#### Thermal Characteristics

Items	Symbol	Min.	typ.	Max.	Units
Thermal resistance, junction to case for IGBT	$R_{th\ j-c}$			0.13	$^{\circ}\text{C}/\text{W}$
Thermal resistance, junction to case for Diode	$R_{th\ j-c}$			0.11	$^{\circ}\text{C}/\text{W}$
Thermal resistance, case to sink	$R_{th\ c-s}$		0.10		$^{\circ}\text{C}/\text{W}$

#### Module Characteristics

Items	Symbol	Conditions	Min.	typ.	Max.	Units
Material of module baseplate				Cu		
Internal isolation		terminal to terminal		$\text{Al}_2\text{O}_3$		
Isolation test voltage	$V_{isol}$	RMS, $f = 50\text{ Hz}$ , $t = 1\text{ min.}$	2.5			kV
Stray inductance module	$L_{sCE}$			30		nH
Mounting torque for modul mounting	M	Screw M6	3.0		5.0	Nm
Terminal connection torque	M	Screw M5	4.0		6.0	Nm
Storage temperature range	$T_{STG}$		-55		150	$^{\circ}\text{C}$
Weight of Module	$W_t$			315		g

#### Internal Circuit:

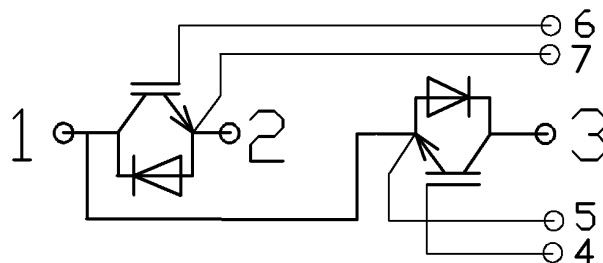

### Representative Characteristics

Fig 1. Output characteristic IGBT

$$I_C = f(V_{CE}), V_{GE} = 15V$$

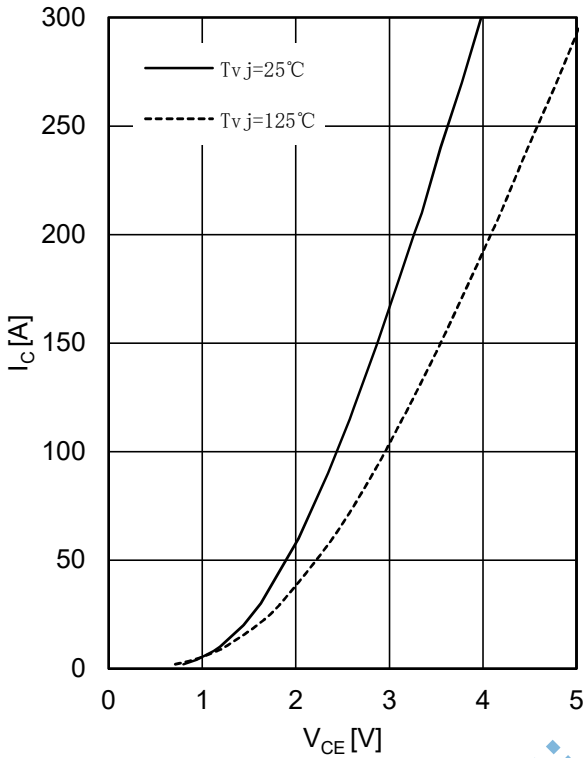

Fig 2. Output characteristic IGBT

$$I_C = f(V_{CE})$$

$$T_{vj} = 125^\circ C$$

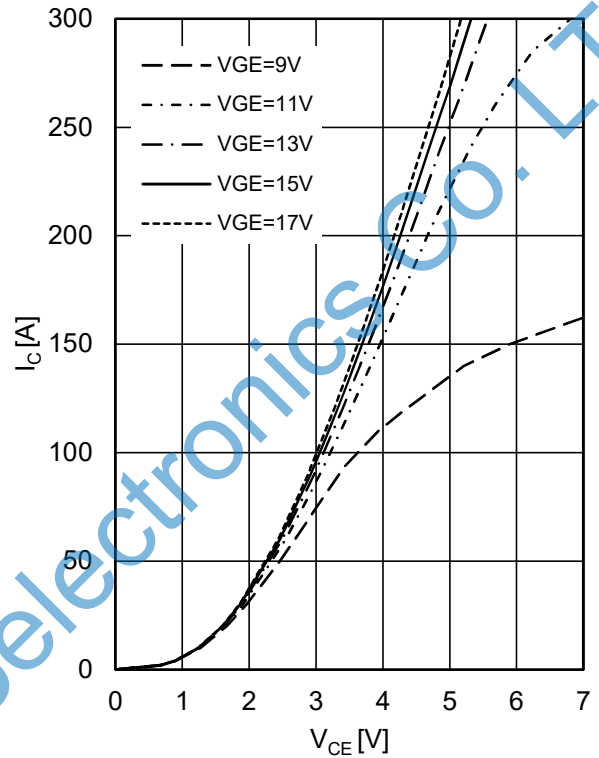

Fig 3. Transfer characteristic IGBT

$$I_C = f(V_{GE})$$

$$V_{CE} = 20V$$

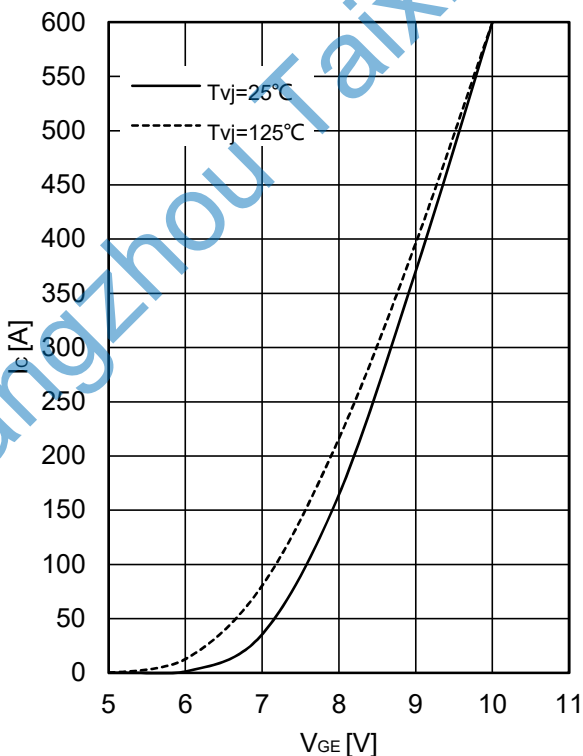

Fig 4. Switching losses IGBT

$$E_{on} = f(I_C), E_{off} = f(I_C)$$

$$V_{GE} = \pm 15V, R_G = 1.1\Omega, V_{CE} = 600V$$

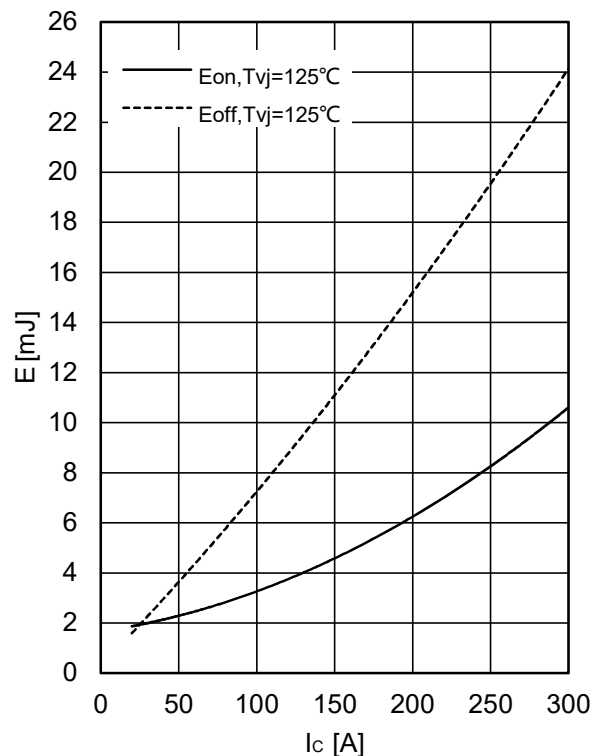

Fig 5. Switching losses IGBT

$$E_{on}=f(R_G), E_{off}=f(R_G),$$

$$V_{GE}=\pm 15V, I_C=150A, V_{CE}=600V$$

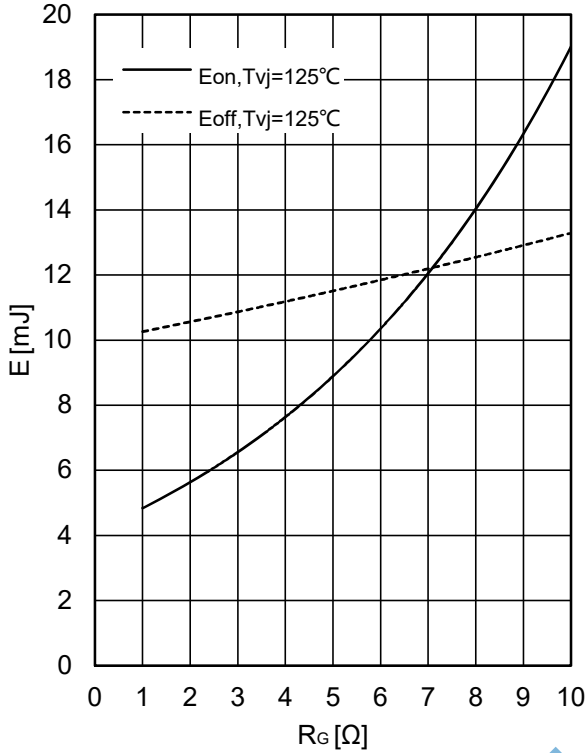

Fig 6. Transient thermal impedance IGBT

$$Z_{thjc}=f(t)$$

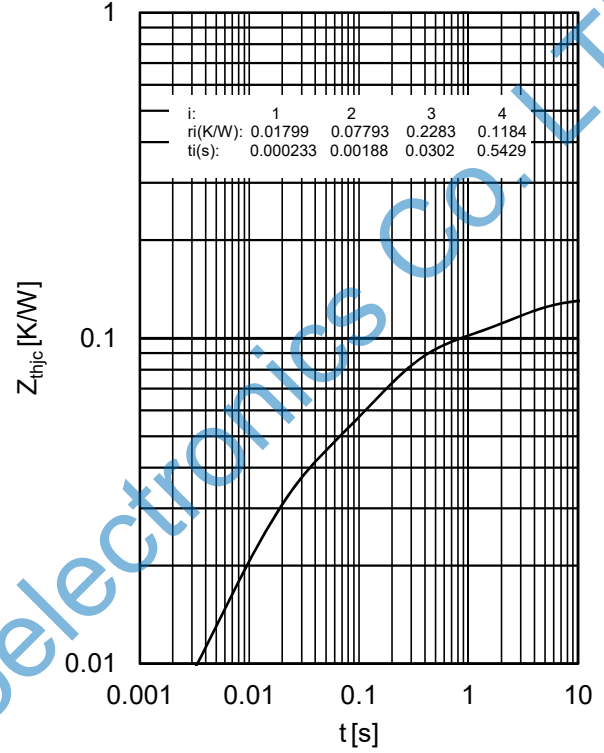

Fig 7. Reverse bias safe operating area IGBT,

$$I_C=f(V_{CE})$$

$$V_{GE}=\pm 15V, R_{Goff}=4.7\Omega, T_{vj}=125^\circ C$$

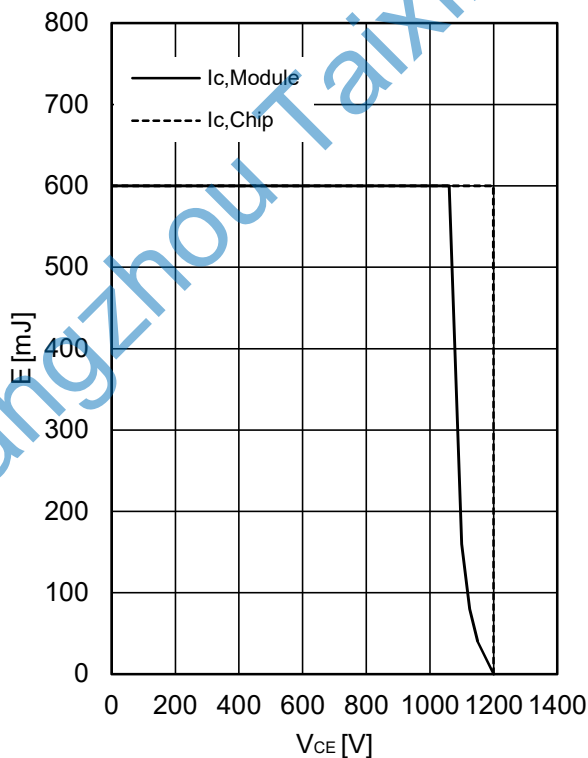

Fig 8. Forward characteristic of Diode

$$I_F=f(V_F)$$

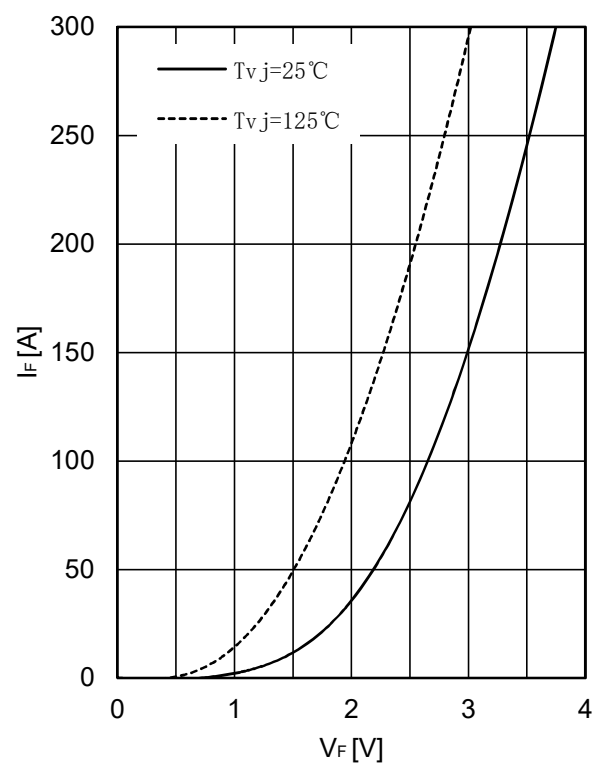

Fig 9. Switching losses Diode

$$E_{rec} = f(I_F)$$

$R_G = 1.1\Omega, V_{CE} = 600V$

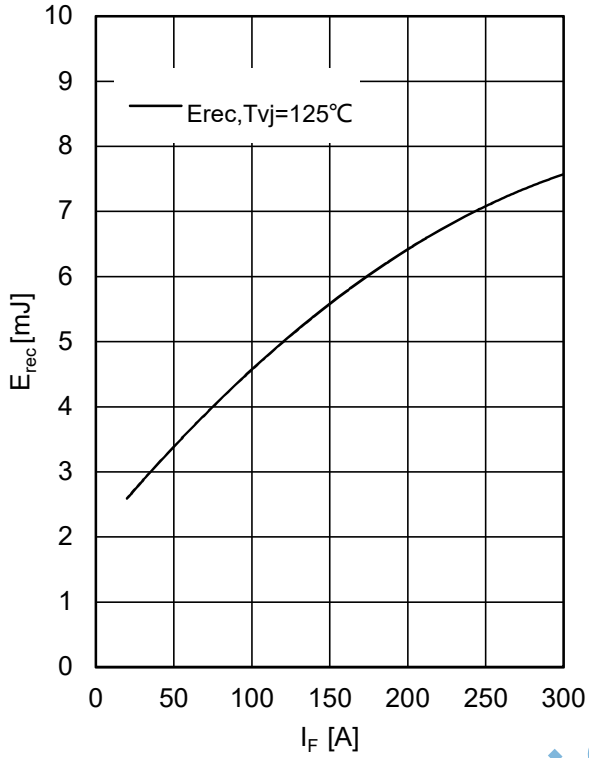
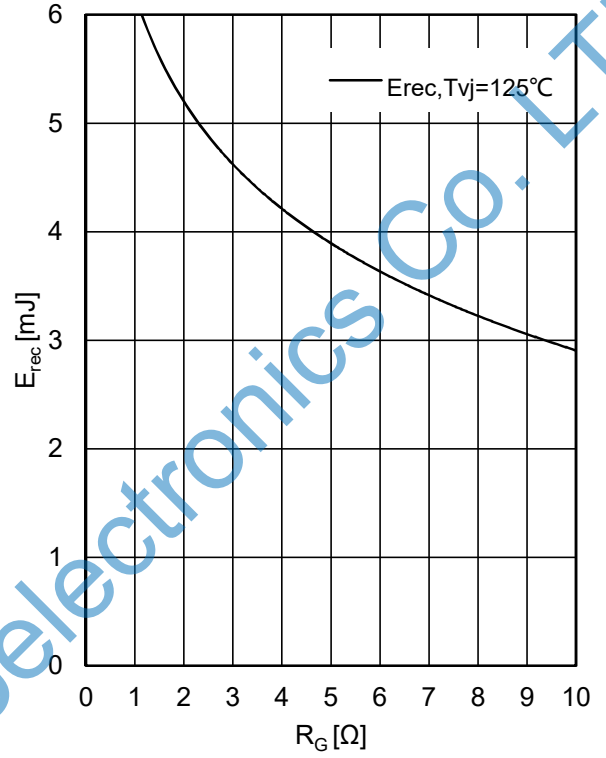

Fig 10. Switching losses Diode

$$E_{rec} = f(R_G)$$

$I_F = 150A, V_{CE} = 600V$



Hangzhou Taixin Microelectronics Co., Ltd.

## Package Dimensions

Dimensions in Millimeters

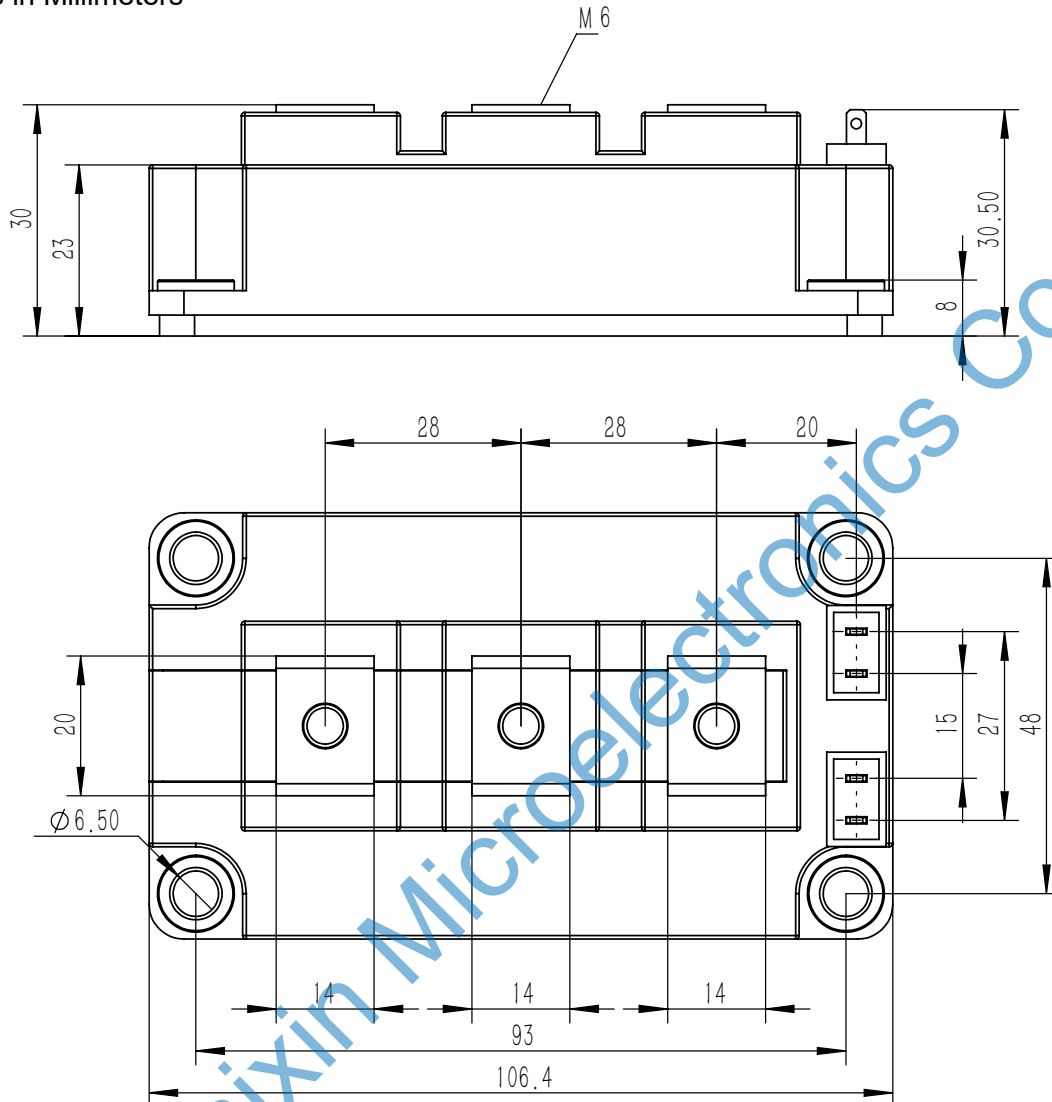

## Terms and Conditions of Usage

The data contained in this product datasheet is exclusively intended for technically trained staff who will have to evaluate the suitability of the product for the intended application and the completeness of the product data with respect to such application.

Information in this document is believed to be accurate and reliable. However, TaiXin does not give any representations or warranties, expressed or implied, as to the accuracy or completeness of such information and shall have no liability for the consequences of use of such information.

If you require product information in excess of the data given in this product data sheet or which concerns the specific application of our product, please contact the Salesman, which is responsible for you. For those that are specifically interested we may provide application notes.

Right to make changes TaiXin reserves the right to make changes to information published in this document, including without limitation specifications and product descriptions, at any time and without notice.